



EN Instruction manual



BOSCH

Table of contents

Important information	5
Before installation	5
Safety information	6
Reasons for damage	6
Your new cooker	7
The control panel	7
Function selector	8
Temperature selector	8
Push-in control knobs (according to models)	9
Control buttons and display panel	9
Types of heating	9
Oven and shelving accessories	11
Cooling fan	13
Before using for the first time	13
Heating up the oven	14
Pre-cleaning the accessories	14
Setting the oven	14
Setting procedure	15
If the oven is to switch off automatically	16
If the oven is to switch on and off automatically	17
Time	18
Setting procedure	18
Timer	19
Setting procedure	19
Basic settings	20
Changing the basic settings	21

Table of contents

Childproof lock	22
Care and cleaning	22
Oven exterior	22
Oven	23
Cleaning function	25
Cleaning the glass panels	26
Cleaning the rails	27
Seal	27
Accessories	27
Troubleshooting	28
Replacing the oven light	28
After-sales service	29
Packaging and old appliances	30
Tables and tips	30
Cakes and pastries	30
Baking tips	32
Meat, poultry, fish, bakes, toast	33
Tips for roasting and grilling	34
Defrosting	35
Drying	35
Energy saving tips	36
Acrylamide in food	36
What can you do?	37
Test dishes	38

Important information

Read this instruction manual carefully. Only then will you be able to operate your cooker safely and correctly. The manufacturer does not accept any responsibility if the instruction manual is not followed.

Please keep the instruction and installation manual in a safe place. Please pass on the instruction manual to the new owner if you sell the appliance.

This instruction manual is for use with both, ovens and cookers. If your appliance is a cooker the operation of the hob is explained in the manual of the hob.

Before installation

Transport damage

Check the appliance after unpacking it. Do not connect the appliance if it has been damaged in transport.

Electrical connection

The cooker may only be connected by an approved specialist. Losses resulting from damage caused by incorrect connection will invalidate warranty claims.

Before using the appliance for the first time, you must ensure that the domestic electrical system is earthed and meets all the current safety regulations. An authorized electrician should install and connect your appliance.

Use of this appliance without an earth connection or incorrectly installed can cause serious injuries (injuries or electrocution), although this is very rare

The manufacturer does not accept any responsibility for any inappropriate use or for any injury caused by incorrect electrical installation.

Safety information

Hot oven



This appliance is intended for domestic use only.
Only use the cooker for food preparation.

Open the oven door carefully. Hot steam may escape.
Never touch the internal surfaces of the oven or the heating elements. There is a risk of burning.
Children must be kept at a safe distance from the appliance.

Never store combustible items in the oven. Risk of fire

Never clamp leads of electrical appliances in the hot oven door. The insulation on the leads could melt.
There is a risk of short-circuiting.

Repairs



Incorrectly done repairs are dangerous. There is a risk of electrocution.

Repairs may only be carried out by after-sales service technicians who have been fully trained by us.

In case of malfunction, disconnect the appliance from the mains.

Call the after-sales service.

Reasons for damage

Baking sheet or aluminium foil on the oven floor

Do not place baking sheets on the oven floor. Do not line the oven floor with aluminium foil.

This causes heat to accumulate. Baking and roasting times will no longer be correct and the enamel will be damaged.

Water in the oven

Never pour water directly into a hot oven. This could damage the enamel.

Fruit juice

When baking very moist fruit cakes, do not put too much on the baking sheet. Fruit juice dripping from the baking sheet leaves stains that cannot be removed.

Cooling with the oven door open

Only leave the oven to cool with the door closed. Do not allow anything to become trapped in the oven door. Even if you only leave the oven door open slightly, the fronts of adjacent units may become damaged over time.

Very dirty oven seal

If the oven seal is very dirty, the oven door will no longer close properly when the oven is in use. The fronts of adjacent units could be damaged. Keep the oven seal clean.

Using the oven door as a seat

Do not stand or sit on the oven door.

Your new cooker

Here you will learn more about your new oven. The control panel and its switches and indicators are explained here. The heating modes and the accessories included with your oven will be explained here.

The control panel

Details vary according to the appliance model.

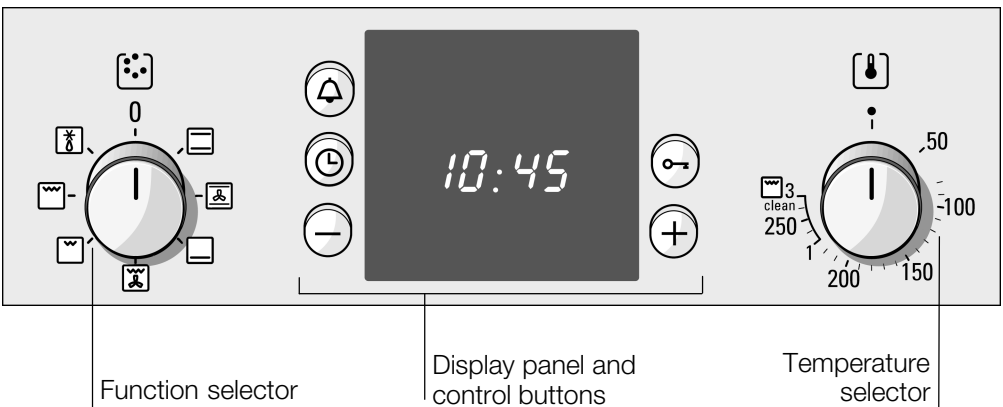

Function selector

Use the function selector to select the type of heating for the oven.

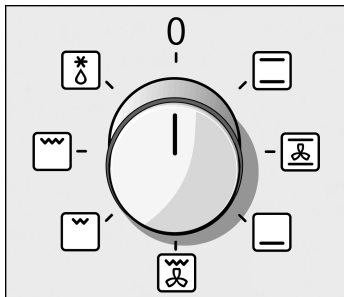

Settings

	Conventional heat
	Hot air
	Bottom heating
	Hot air grilling
	Radiant grill - small area
	Radiant grill - large area
	Defrosting

When you select a function, the oven light switches on.

Temperature selector

Use the temperature selector to set the temperature or grill setting.

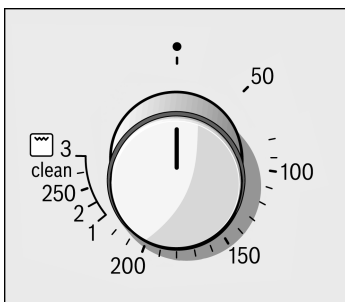

Temperature

50 - 270	Temperature range in °C
----------	-------------------------

Grill

1	Low grill
2	Medium grill
3	High grill
clean	Cleaning function

Grill settings

You can select a grill setting on the radiant grill using the temperature selector.



When using the grill for more than 15 minutes of cooking time, turn the temperature knob to low grill.



Push-in control knobs (according to models)

The control knobs can be pushed in. Simply press the control knob to release or lock it.

The function selector can be turned clockwise or anticlockwise, whereas the temperature selector can only be turned clockwise.

Control buttons and display panel



Minus button -	Use this button to reduce the values set.
Plus button +	Use this button to increase the values set.
Clock button ⌚	Use this button to set the time of day, the cooking time I→I and the completion time I→I.
Key button 	Use this button to switch the childproof lock on and off.
Timer button 	Use this button to set the timer.

The values set can be seen in the display panel.

Types of heating

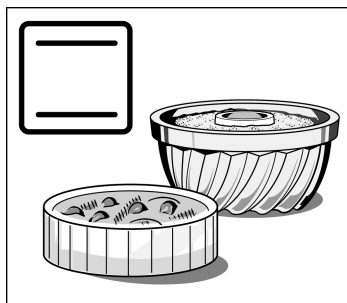

Different types of oven heating are available. You can therefore select the best method for cooking any dish.

Top/bottom heating

This ensures the even distribution of heat onto the cake or roast from the top and bottom of the oven. This type of heating is best for cake mixtures in tins or for bakes. Top/bottom heating is also suitable for cooking lean roasts of beef, veal and game.

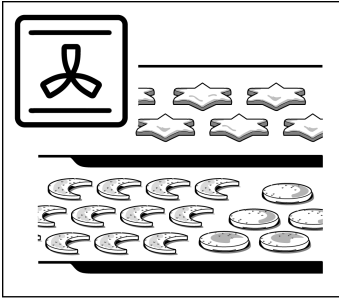

Hot air

A cooling fan in the oven's back wall distributes the heat in a uniform manner throughout the oven. Using hot air, it is possible to bake cakes and pizza on two shelves.

When cooking on two levels, place the aluminium tray on the lower level. Additional trays may be purchased from a specialist shop.

The required oven temperatures are lower than those for top/bottom heating.

Hot air is ideal for drying food.

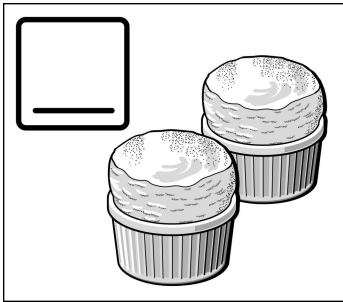

Bottom heating

You can reheat or brown meals using bottom heating. It is also suitable for making jam and marmelade.

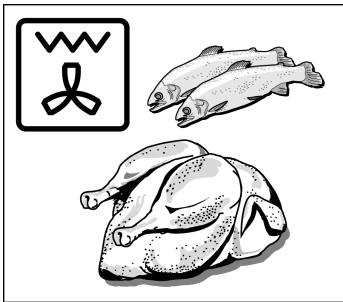

Hot air grilling

This type of heating involves the grill element and the fan switching on and off alternately. During the pause in heating, the fan circulates the heat generated by the grill around the food. This ensures that pieces of meat are crisped and brown on all sides.

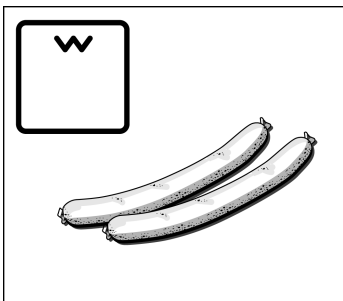

Radiant grill - small area

The entire area under the grill element becomes hot. This is ideal if you wish to cook several steaks, sausages, fish or slices of toast.

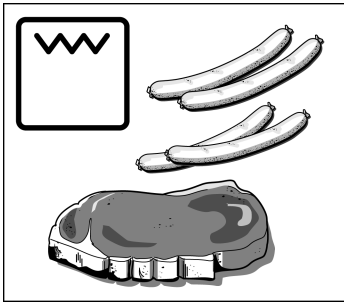

Radiant grill – large area

The entire area under the grill element becomes hot. This is ideal if you wish to cook several steaks, sausages, fish or slices of toast.

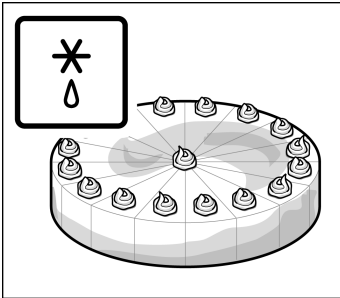

Defrosting

A fan in the rear wall of the oven circulates the air in the oven around the frozen food. Frozen pieces of meat, poultry, bread and cakes defrost evenly.

Oven and shelving accessories

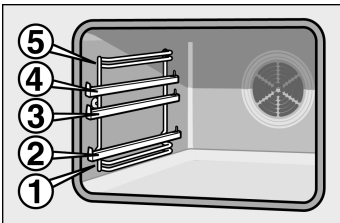

The shelf can be inserted at 5 different heights in the oven.

Some of these levels may have slides which make it possible to remove accessories without them tipping. This makes it easy to remove dishes.

Accessories

Accessories can be purchased from the technical assistance service or specialist retailers.

Your oven may include any of the following accessories:

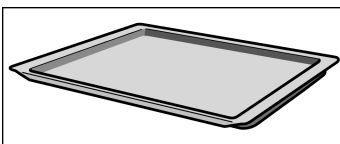

Enamel baking tray

For moist cakes, pastries, frozen food and large roasts. It can also be used to catch dripping fat when you are grilling directly on the wire grill.

Push the baking tray with the sloping edge facing towards the oven door.

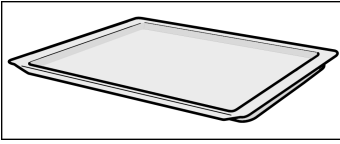

Aluminium tray

For cakes and biscuits.

Push the baking tray as far as possible into the oven, with the sloping edge facing towards the oven door.

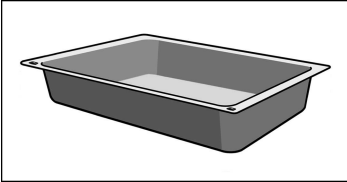

Moussaka pan

Ideal for bakes made from cooked or raw ingredients. The moussaka pan is also suitable for using as an open dish for roasting meat in. It can also be used to catch dripping fat when you are grilling directly on the wire rack.

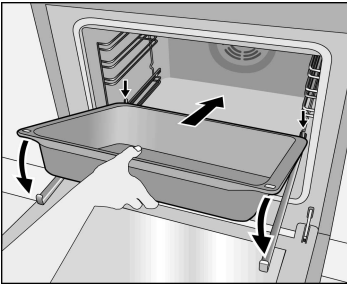

Place the tray on the slides (see image);

Make sure that the holes face outwards.

Place and fit the tray on the slides.

Attach the hooks to the tray.

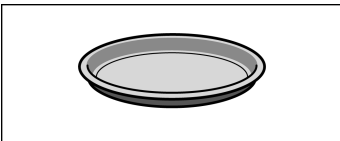

Pizza tray

Ideal for pizza, frozen foods and large round cakes, for example. You can use the pizza tray instead of the enamel tray. Place the tray on the wire grill.

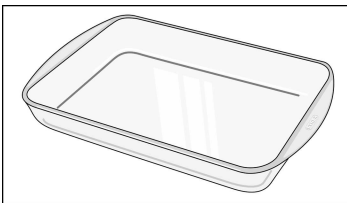

Glass casserole dish

For all types of baked meats and fish.

Always use with the wire grille.

Place the glass casserole dish in the centre of the wire grille for a perfect roast.

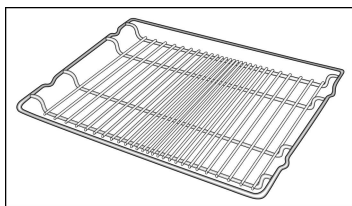

Wire rack

For ovenware, cake tins, roasts, grilling and frozen meals.

Insert the wire rack curving downwards .

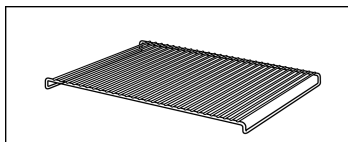

Wire rack

For grilling. Always place the wire grill in the baking tray. Fat and meat juices are collected.

Cooling fan

The oven is fitted with a cooling fan. It switches itself on and off as necessary. The warm air escapes above the door.

Before using for the first time



This section will tell you everything you need to do before using the cooker for the first time.

Heat the oven and clean the accessories. Read the safety instructions in the “Important information” section.

Firstly, check to see if the  symbol and three zeros are flashing in the display.

If the  symbol and three zeros are flashing in the display

Set the time.

1. Press the  clock button.
12:00 appears and the  clock symbol flashes.
2. Set the time using the + or – button.

The time selected is adopted after a few seconds. The cooker is now ready for use.

Heating up the oven

Method

Heat the empty oven with the door closed to remove the new oven smell.

1. Set the function selector to .
2. Use the temperature selector to set the temperature to 240 °C.

Switch off the function selector after 60 minutes.

Pre-cleaning the accessories

Please wash the accessories thoroughly with soapy water and a cleaning cloth before using them.

Setting the oven

Switching off the oven manually

You have various options for setting the oven.

When your meal is ready, switch off the oven yourself.

The oven switches off automatically

You can leave the kitchen for a long period.

The oven switches on and off automatically

You can put your meal in the oven in the morning, for example, and set the oven so that your meal is ready at midday.

Tables and tips

The correct settings for many dishes can be found in the Tables and tips section.

Setting procedure

Example: Top/bottom heating , 190 °C

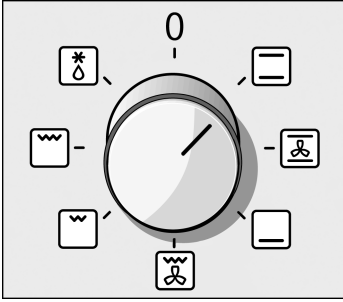

1. Select the desired type of heating using the function selector.

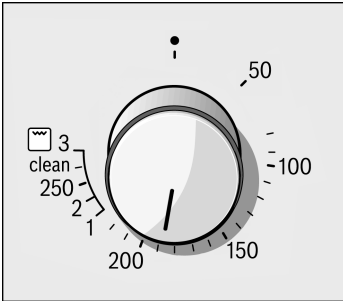

2. Use the temperature selector to set the temperature or grill setting.

Switching off

Switch off the function selector when the meal is ready.

Changing the setting

You may change the temperature or grill setting at any time.

If the oven is to switch off automatically

Example: Cooking time of 45 minutes

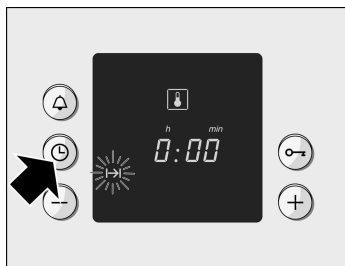

3. Press the ⌚ clock button.
The cooking time symbol I→I will flash.

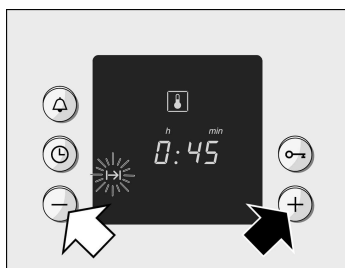

4. Set the cooking time using the + or – button.
+ button default value = 30 minutes.
– button default value = 10 minutes.

The oven switches on after a few seconds.
The I→I symbol lights up in the display.

The cooking time has elapsed

A signal sounds. The oven switches off.
Press the ⌚ button twice and switch off the function selector.

Changing the setting

Press the ⌚ clock button. Change the cooking time using the + or – button.

Cancelling the setting

Press the ⌚ clock button. Press the – button until the display is at zero. Switch off the function selector.

Setting the cooking time when the clock time is hidden

Press the ⌚ clock button twice and perform the setting as described in item 4.

If the oven is to switch on and off automatically

Example: Imagine – it's 10:45 a.m. The meal will take 45 minutes to cook and must be ready at 12:45 pm.



5. Press the ⌚ clock button until the → symbol flashes.

In the display you will see the time when the meal will be ready.

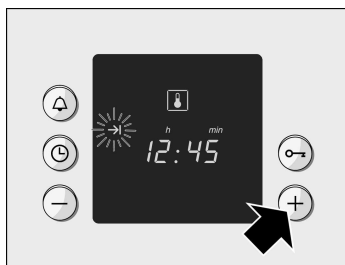

6. Use the + button to set a later end time.

The setting is adopted after a few seconds. The display will show the end time until the oven switches on.

The cooking time has elapsed

A signal sounds. The oven switches off. Press the ⌚ button twice and switch off the function selector.

Note

You can change the setting while the symbol is flashing. The setting has been adopted if the symbol lights up permanently. You may change the waiting time that elapses before the setting is adopted. See the Basic settings section for more details.

Time

When the oven is first connected, or following a power cut, the ☹ symbol and three zeros flash in the display. Set the time.

The function selector must be switched off.

Setting procedure

Example: 13:00



1. Press the ☹ clock button.
12.00 appears in the display and the ☹ symbol flashes.

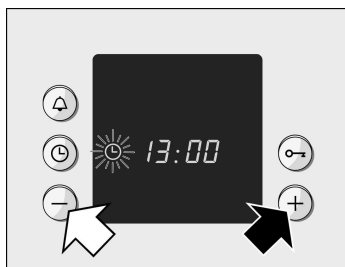

2. Set the time using the + or – button.

The time selected is adopted after a few seconds.

Changing the time e.g. from summer to winter time

Press the ☹ clock button twice and change the time with the + or – button.

Hiding the time

You can hide the time. It will then only be visible when you are performing settings.

To do this, you must change the basic setting. See the “Basic settings” section.

Timer

You can use the timer as a kitchen timer. It operates independently of the oven.



The timer has a special signal. This means that you can tell whether the set timer period has elapsed or the cooking time is complete.

You can also set the timer if the childproof lock is active.

Setting procedure

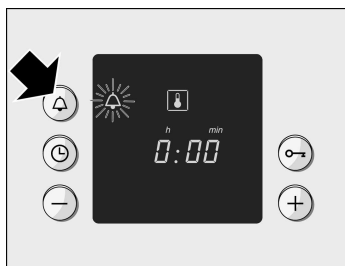
Example: 20 minutes



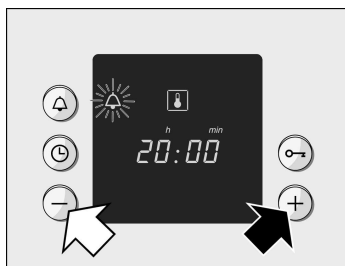

1. Press the  timer button.
The  symbol will flash.



2. Set the timer period using the + or – button.
+ button default value = 10 minutes.
– button default value = 5 minutes.

The timer starts after a few seconds. The  symbol lights up in the display. The time counts down visibly.

The time has elapsed

A signal sounds. Press the  timer button. The timer display  will go out.

Changing the timer period

Press the  timer button. Change the time using the + or – button.

Cancelling the setting

Press the  timer button. Press the – button until the display is at zero.

The timer and cooking time count down simultaneously

The symbols light up. The timer period counts down visibly in the display.

To call up the remaining cooking time **I→I**, end time **I→I** or time **⌚**: Press the **⌚** clock button until the symbol in question flashes.

The value called up will then appear in the display for a few seconds.

Basic settings

Your oven has several basic settings. You may change the basic settings for time, the signal duration and the reset time for a setting.

Basic setting	Function	Change to
Time ⌚ I = Time in the foreground	Time display	Time ⌚ = Time hidden
Signal duration ⚡ 2 = approx. 2 mins.	Signal after cooking time or timer period has elapsed.	Signal duration I = approx. 10 seconds 3 = approx. 5 mins.
Reset time I→I 2 = medium	Waiting time between the adjustment increments before the setting is adopted.	Reset time I = short 3 = long

Changing the basic settings

Example: Hiding the time

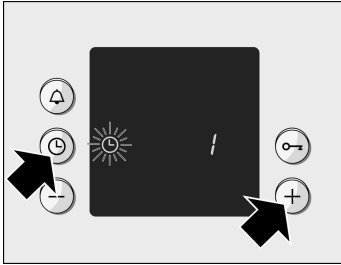

There must be no program set.

1. Press the ⌚ clock button and the + button at the same time until a **!** appears in the display. This is the basic setting for the time in the foreground.

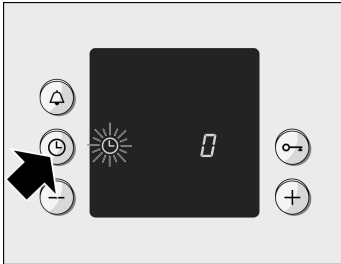

2. Change the basic setting using the + or – button.

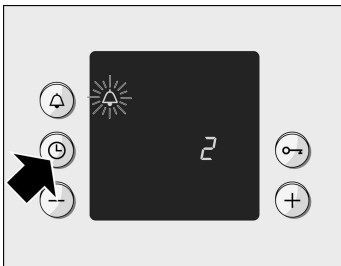

3. Confirm with the ⌚ clock button.

A **2** will appear in the display for the basic setting for the signal duration.

Change the basic setting as described in step 2 and confirm with the ⌚ clock button. You can now change the reset time. To finish press the ⌚ clock button.

You do not wish to change all the basic settings

If you do not wish to change a basic setting, press the ⌚ clock button. The next basic setting will appear.



Correcting settings

You may change your settings again at any time.

Childproof lock

The oven has a childproof lock to prevent children from switching it on accidentally.

Locking the oven

Press the  key button until the  symbol appears in the display. This will take approximately 4 seconds.

Unlocking

Press the  key button until the  goes out.

Notes

You can set the timer and the clock even when the oven is locked.

The childproof lock setting will be lost if there is a power cut.

Care and cleaning

Do not use high-pressure cleaners or steam jets.

Oven exterior

Wipe the oven with water and a little washing-up liquid. Dry it with a soft cloth.

Caustic or abrasive substances are not suitable. If any such substances come into contact with the frontage, wipe it off immediately with water.

Slight differences in the colours on the appliance front are caused by the use of different materials, such as glass, plastic and metal.

Appliances with stainless steel fronts

Always remove any flecks of limescale, grease, cornflour and egg white immediately. Corrosion can form under such flecks.

Use stainless steel care products. Follow the manufacturer's instructions. Try out the product on a small area first, before using on the whole surface.

Oven

Never use coarse scouring pads or cleaning sponges. Oven cleaner may only be used on enamelled oven surfaces.

For ease of cleaning

you can switch on the oven light and detach the oven door.

Switching on the oven light

Set the function selector to . The temperature selector must be set to the off position.

Detaching the oven door

The oven door can be easily detached.

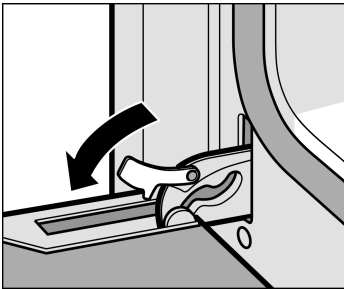

1. Open the oven door fully.
2. Move the two locking levers on the left and right-hand sides.

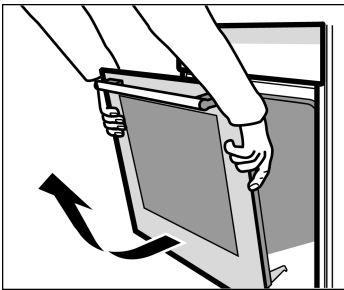

3. Half-close the oven door.
With both hands, grip the bottom of the door on the left and right-hand sides.
Close the door a little more and pull it out.

After cleaning, re-install the oven door, following the instructions in reverse order.

Folding down the grill element

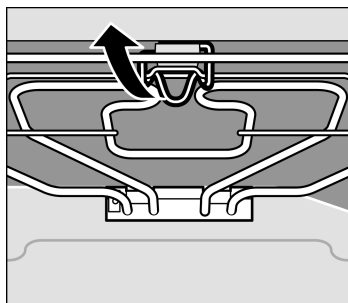

Fold down the grill element to facilitate cleaning of the oven cover.

Warning: the oven must be cold. There is a risk of burning.

Pull the handle on the folding grill towards the front and push it upwards until you hear it click into place. At the same time, hold the grill element and fold it down.

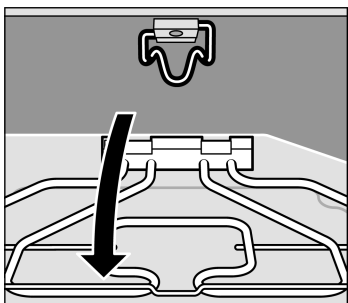

After cleaning:

Fold the grill element back up. Push the handle down until the grill element engages.

Cleaning the catalytic surfaces of the oven

The rear wall, top and side walls of the oven are coated with self-cleaning enamel. The surfaces clean themselves while the oven is in operation. Large splashes may only disappear after the oven has been used several times.

Never use oven cleaner on self-cleaning surfaces.

If the self-cleaning surfaces of the oven are no longer cleaning themselves sufficiently, they can be regenerated using the cleaning function.

Should the enamel become slightly stained, this will not affect its self-cleaning properties.

Cleaning the oven floor

Use hot soapy water or a vinegar solution.

It is best to use oven cleaner if the oven is very dirty.

Only use oven cleaner in a cold oven.

Never use oven cleaner on the self-cleaning surfaces of the oven.

Note:

Enamel is baked on at very high temperatures. This can cause some slight colour variation. This is normal and does not affect the function. Do not use coarse scouring pads or strong cleaning agents to remove such discolorations.

The edges of thin trays cannot be completely enamelled. As a result, these edges can be rough. Anti-corrosion protection is guaranteed.

Cleaning the glass cover for the oven light

It is best to clean the glass cover with washing-up liquid.

Cleaning function



The cleaning function is a regeneration program. If the self-cleaning components of the oven are no longer cleaning themselves sufficiently, they can be regenerated using this function. They are then fully operational again.

Remove accessories and ovenware from the oven.

Caution

Before you do this, you must clean the oven surfaces which are not self-cleaning. Otherwise stains may appear that cannot be removed.

Setting procedure

1. Set the function selector to hot air .
2. Set the temperature selector to clean.
3. Press the  button until the  symbol flashes.
4. Use the + button to set 1.00 hour.

The setting is adopted after a few seconds.

The oven will switch off automatically after one hour.

Switch off the function selector.

When the oven has cooled

Wipe away salt residues from the self-cleaning components using a moist cloth.

Cleaning the glass panels

The glass panel on the oven door can be removed to assist in cleaning.

1. Remove the oven door and lay it on a cloth with the handle underneath.
2. Unscrew the cover at the top of the oven door. To do this, undo the right and left-hand screws (Fig. A)

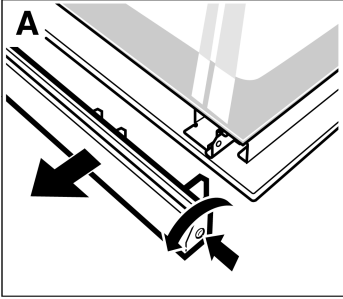

3. Slide out the panel. (Fig. B)

Clean the glass panel with glass cleaner and a soft cloth.

4. Push the panel back in. Make sure that the smooth surface is facing outwards.
5. Replace the cover and screw it back on.
6. Refit the oven door.

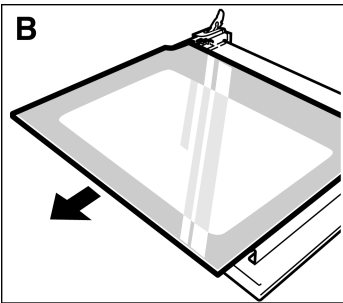

The oven must not be used again until the panel has been correctly installed.

Cleaning the rails

The rails can be removed for cleaning.

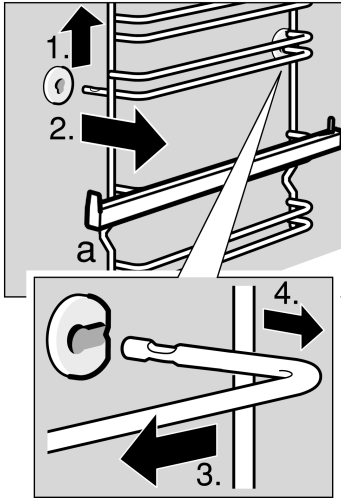

To unhook the rails:

1. Lift the rails at the front in an upwards direction
2. and unhook them,
3. then pull the rails forward
4. and remove

Clean the rails using either washing-up liquid and a sponge or a brush.

To hook rails back into position:

Insert the rails at the rear, push them backwards slightly and hook them in at the front.

The rails fit both the left and right sides. Recess (a) must always be at the bottom.

Seal

Clean the seal on the oven with washing-up liquid. Never use caustic or abrasive detergents.

Accessories

Immediately after use, soak the accessories in washing-up liquid. Food residues can then be easily removed with a brush or sponge.

Troubleshooting

Should a malfunction occur, it is often only due to a minor fault. Please read the following instructions before calling the after-sales service:

Problem	Possible cause	Comments/remedy
The oven does not work.	Blown fuse.	Look in the fuse box and check that the fuse is in working order.
The clock display flashes.	Power cut	Check whether the kitchen light switches on.

Repairs may only be carried out by fully trained after-sales service technicians.

Improper repairs may constitute serious hazards to the user.

Replacing the oven light

If the oven light fails, it must be replaced. Heat-resistant spare bulbs can be obtained from the after-sales service or specialist shops. Only use these bulbs.

Method

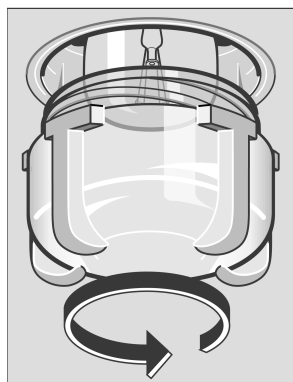

1. Disconnect the appliance from the mains.
2. Place a tea towel in the cold oven to prevent damage.
3. Unscrew the glass cover by turning it anti-clockwise.
4. Replace the oven light with one of the same type.
5. Screw the glass cover back on.
6. Remove the tea towel and connect the appliance from the mains.

Replacing the glass cover

The glass cover on the oven light must be replaced if it is damaged. Replacement glass covers may be obtained from the after-sales service. To this end, please specify the E number and FD number of your appliance.

After-sales service

Our after-sales service is there for you if your oven needs repairing. You will find the address and telephone number of your nearest after-sales service centre in the phone book. The after-sales service centres listed will also be happy to advise you of a service point in your local area.

E number and FD number

Please quote the E number (product number) and the FD number (production number) of your appliance when contacting the after-sales service. The rating plate containing these numbers is found on the right, on the side of the oven door. You can make a note of these numbers in the space below to save time in the event of your appliance malfunctioning.

E no.	FD no.
-------	--------

After-sales service 

Packaging and old appliances

Disposing in an environmentally-responsible manner

Unpack the appliance and dispose of the packaging in an environmentally-responsible manner.



This appliance is marked according to the European directive 2002/96/EC on Waste Electrical and Electronic Equipment (WEEE).

This guideline is the frame of a European-wide validity of return and recycling on Waste Electrical and Electronic Equipment.

Tables and tips

This table contains a selection of dishes and the optimum settings at which to cook them. You can find out which type of heating and temperature is best for your dish, which accessories to use, and at which oven level the dish should be inserted. You will find a variety of tips about ovenware and preparation, and a small troubleshooting section in case anything should go wrong.

Cakes and pastries

Baking tins

It is best to use dark baking tins. You should use hot air when using shiny baking tins, or glass containers. This means, however, that the baking time is increased and the cake does not brown so evenly.

Place the cake tin on the wire rack.



Tables

The values in the table apply to dishes placed in a cold oven. This saves energy. Shorten the baking times indicated by 5 to 10 minutes if you have preheated the oven.









The tables show which type of heating is best for different cakes and bakes.

The temperature and cooking time you select depends on the quantity and type of pastry. This is why “ranges” are given in the tables. You should try to use a lower temperature setting to start with, since this allows more even browning. If necessary, use a higher temperature setting the next time.

More information can be found in the “Baking tips” section which follows the tables.

Bread and bread rolls		Level	Type of heating	Temperature in °C	Duration, minutes
Yeast bread with 1.2 kg flour* (preheat)	Enamel baking tray	2		270	8
				200	40-50
Sour dough bread with 1.2 kg flour* (preheat)	Enamel baking tray	2		270	8
				200	35-45
Bread rolls (preheat)	Enamel baking tray	4		200-220	20-30

* Never pour water directly into a hot oven.

Biscuits		Level	Type of heating	Temperature in °C	Baking time in minutes
Cookies	Tray	3		150-170	10-20
	2 trays*	2+3		140-160	25-35
Meringue	Tray	3		80-100	120-150
Choux pastry	Tray	2		190-210	30-40
Macaroons	Tray	3		100-120	30-40
	2 trays*	2+3		100-120	35-45
Puff pastry	Tray	3		170-190	20-30
	2 trays*	2+3		170-190	30-40

* If you are using both levels of the oven, place the enamelled tray in the higher position.

* You can obtain an additional baking tray from a specialist shop or from the after-sales service.

Baking tips

You wish to cook to your own recipe.	Refer to the instructions in the tables for similar types of food.
How to check that a sponge cake is cooked properly.	Approximately 10 minutes before the end of the baking time given in the recipe, pierce the tallest point of the cake with a cocktail stick. The cake is done if the cocktail stick comes out clean.
The cake collapses.	Next time, use less liquid or decrease the oven temperature by 10 degrees. Observe the cooking times in the recipe.
The cake has risen in the centre but is lower at the edges.	Do not grease the sides of the springform cake tin. As soon as the cake is done, carefully loosen the cake around the edges using a knife.
The cake is too dark at the top.	Insert it at a lower level in the oven, select a lower temperature and cook the cake a little while longer.
The cake is too dry.	Use a toothpick to make small holes in the finished cake. Then drizzle fruit juice or alcohol over the top. Next time you should decrease the temperature by around 10 degrees and reduce the baking times.
The bread or cake (e.g. cheesecake) looks fine, but is soggy on the inside (soft, with watery areas).	Next time you should add a little less liquid and cook for a little longer at a lower temperature. Cakes with fruit topping: Precook the base first of all. Sprinkle with almonds or breadcrumbs and then place the topping over this. Please observe the recipe and the baking times.
The pastry is unevenly browned.	Select a slightly lower temperature to ensure that the pastry is baked more evenly. Delicate pastry should be baked on one level using top/bottom heating  . Baking paper that protrudes over the food can affect the air circulation. For this reason, always cut the baking paper to fit the baking tray.
You were baking on several levels. The food on the top baking tray is darker than that on the bottom baking tray.	Always use hot air  when baking on several levels. Baking trays that are placed in the oven at the same time will not necessarily be ready at the same time.
Condensation is formed when baking cakes containing fresh fruit.	Baking may result in the formation of water vapour. It escapes above the door handle. The steam may settle and form water droplets on the control panel or on the fronts of adjacent units. This is a normal physical process.

Meat, poultry, fish, bakes, toast

Ovenware

You may use any heat-resistant dishes.

Always place the dishes in the centre of the wire grill.

Hot glass dishes should be placed on a dry kitchen towel after being removed from the oven. The glass could crack if placed on a cold or wet surface.

Advice on roasting

The roasting result depends on the type and quality of meat.

Add 2 to 3 soup spoons of liquid to lean meat, and 8 to 10 soup spoons of liquid to pot roasts, depending on the size.

Meat should be turned half way through the roasting time.

When the roast is ready, switch off the oven and leave the roast to stand for 10 minutes with the oven door closed. This allows the meat juices to distribute more favourably.

Advice on grilling







Always close the oven door when grilling.

If possible, use pieces of meat which are of the same thickness. They should be at least 2 to 3 cm thick. Such pieces will be browned evenly and stay juicy and soft in the middle. Only salt the steaks after they have been grilled.

Place the pieces of meat directly onto the wire grill. If you are grilling just one piece of meat, it will turn out best if you place it in the centre of the wire grill. Additionally, slide the enamelled tray in at height position 1. The meat juices are collected here and the oven is kept clean.

Turn the pieces of meat after two thirds of the cooking time indicated.

The grill element automatically switches itself off and back on again. This is normal. The number of times this happens depends on the grill setting you have selected.

Example	Amount	Ovenware	Level	Type of heating	Temperature in °C, grill	Cooking time in minutes
Sirloin, medium-rare	1 kg	Uncovered	1		230-240	30
Roast beef, medium	1 kg	Uncovered	1		240-250	50
Leg of lamb	1.5 kg	Uncovered	1		160-180	120
Potato gratin*		Soufflé mould or enamel tray	2		150-170	60
Toast		Wire grill	4		setting 3	4-5
Grilled fish	300 g	Wire grill**	4		setting 1-2	25

* The bake should be no taller than 2 cm.

** Slide the enamelled tray in at level 1.

Tips for roasting and grilling

The table does not contain information for the weight of the roast.

Select the next lowest weight from the instructions and extend the time.

How can you tell when the roast is ready?

Use a meat thermometer (available from specialist shops) or carry out a "spoon test". Press down on the roast with a spoon. If it feels firm, it is ready. If the spoon can be pressed in, it needs to be cooked for a little longer.

The roast is too dark and the crackling is partly burnt.

Check the shelf position and temperature.

The roast looks good, but the juices are burnt.

Next time, use a smaller roasting dish or add more liquid.

The roast looks good, but the juices are too clear and watery.

Next time, use a larger roasting dish or add less liquid.

Steam rises from the roast when the juice is basted.

Use hot air grilling instead of top/bottom heating. This prevents the bottom of the roast from becoming too hot, thereby producing less steam.

Defrosting

Remove the food from its packaging and place it in a suitable dish on the wire grill.

Please observe the instructions on the packaging.

The defrosting times depend on the type and amount of food.

Meal	Accessories	Level	Type of heating	Temperature in °C
Frozen foods* e.g. cream gateaux, cream cakes, cakes with chocolate or icing, fruit, chicken, sausages and meat, bread, rolls, pastries and other baked goods	Wire rack	2		The temperature selector remains switched off





* Cover frozen food with microwave foil. Place poultry onto the plate with the breast side down.

Drying

Only use perfectly fresh fruit and vegetables, and wash them thoroughly.

Allow the food to drain well and dry it yourself.

Line the enamel tray and wire rack with baking paper or greaseproof paper.

Meal	Level	Type of heating	Temperature in °C	Cooking time in hours
600 g apple rings	2 + 3		80	Approx. 5
800 g sliced pears	2 + 3		80	Approx. 8
1.5 kg prunes or plums	2 + 3		80	Approx. 8 - 10
200 g fresh herbs, washed	2 + 3		80	Approx. 1½

Note

Very moist fruit or vegetables should be turned several times. Once dried, remove the food from the paper immediately.

Energy saving tips

Only preheat the oven if it specifies in the recipe or in the table in the instruction manual that you should do so.

Use non-stick, black painted or enamelled tins. They absorb the heat especially well.

If you have several cakes to bake it is best to bake them one after the other. The oven is still warm. This shortens the baking time for the second cake. You can also put two baking tins in one after the other.

For long cooking times, the oven can be switched off 10 minutes before the end of the cooking time and the remaining heat can be used to finish the cooking.

Acrylamide in food

Experts are currently discussing how dangerous acrylamide in food can be. We have compiled this information sheet for you on the basis of current research.

Where does acrylamide come from?

Acrylamide in food does not come from external contamination. It is formed in the food itself during preparation - provided that the food contains carbohydrate and protein. Exactly how this happens has not yet been completely explained. However, it appears that the acrylamide content is strongly influenced by:

- high temperatures
- a low water content in food
- intensive browning of the food.

What sort of foods are affected?

Acrylamide forms mostly in grain and potato products that are prepared at high temperatures, e.g.:

- crisps, chips,
- toast, rolls, bread,
- baked goods made from shortcrust pastry (speciality biscuits and cakes).

What can you do?

You can avoid high levels of acrylamide when baking, frying and grilling.

The following recommendations were published by AID¹ and BMVEL² to help you minimise acrylamide levels:

In general

Keep cooking times as short as possible.

“Brown rather than burn” - cook food only until it is golden brown.

The larger and thicker the food is, the less acrylamide it contains.

Baking

Set the temperature to a maximum of 180 °C when using the hot air setting.

Cookies: Set the temperature to a maximum of 170 °C when using the hot air setting. The presence of egg or egg yolk in a recipe reduces the formation of acrylamide.

Spread oven chips evenly over the baking sheet in one layer where possible. To prevent the food from drying out quickly, place at least 400 g on each baking sheet.

¹ AID “Acrylamide” information leaflet, published by AID (German Evaluation and Information Service for Nutrition, Agriculture and Forestry) and BMVEL (German Federal Ministry for Consumer Protection, Food and Agriculture), as at 12/02, Internet: <http://www.aid.de>









² BMVEL press release 365, as at 4.12.2002, Internet:<http://www.verbraucherministerium.de>

Test dishes

In accordance with DIN 44547 and EN 60350

Baking

The values in the table apply to dishes placed in a cold oven.

Meal	Accessories and notes	Level	Type of heating	Temperature in °C	Baking time in minutes
Viennese whirls	Baking tray	3		160-180	20-30
	Baking tray + enamel tray*	2+3		140-160	30-40
Small cakes x 20	Baking tray	3		160-180	25-35
Small cakes, 20 per baking tray (preheat)	Baking tray + enamel tray*	2+3		150-170	25-35
Swiss roll	Springform cake tin	2		160-180	30-40
Yeast cakes on a baking tray	Enamel tray	3		170-190	40-50
	Baking tray + enamel tray*	2+3		160-180	50-60
German apple pie	2 wire racks + 2 tinplate springform cake tins Ø 20 cm**	2+3		190-210	70-80
	Enamel tray+ 2 tinplate springform cake tins Ø 20 cm**	1		190-210	70-80



Baking trays may be obtained as optional accessories from specialist shops.

*

** Place the cakes diagonally on the accessories.

Grilling

The values in the table apply to dishes placed in a cold oven.

Meal	Accessories	Level	Type of heating	Grill setting	Cooking time in minutes
Toast (preheat for 10 mins.)	Wire rack	5		3	1-2
Beefburgers, x 12*	Wire rack	4		3	25-30

* Turn half way through the cooking time. Always insert the enamel tray at level 1.

DE <http://www.bosch-hausgeraete.de>
GB <http://www.boschappliances.co.uk>
FR <http://www.bosch-electromenager.com>
NL <http://www.bosch-huishoudelijke-apparaten.nl>
FI <http://www.bosch-kodinkoneet.com>
DK <http://www.bosch-hvidevarer.com>
ES <http://www.bosch-ed.com>
PT <http://www.bosch.pt>
BE <http://www.electro.bosch.be>
AU <http://www.bosch.com.au>
AT <http://www.bosch-hausgeraete.at>
BR <http://www.boschelectrodomesticos.com.br>
GR <http://www.bosch-home.gr>
US <http://www.boschappliances.com>

9000195790 (1W052B) 00 8610